

Sf₆ Load Break Switch

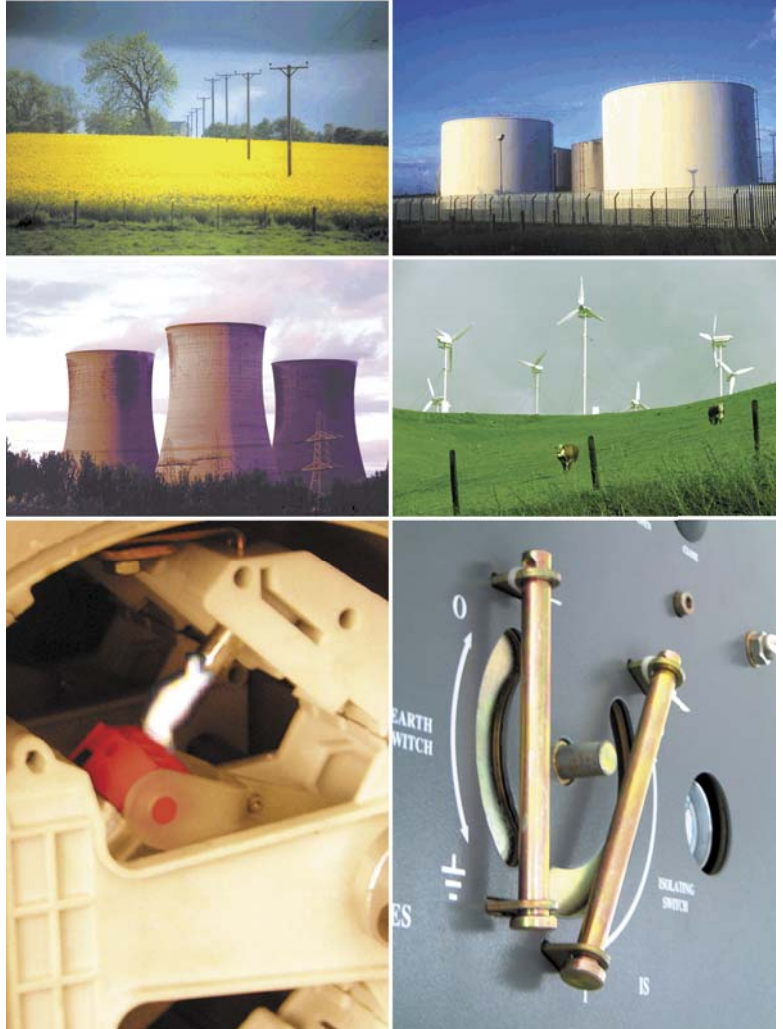

12/24kV
LKE-GLBS Switch
LCA-G Air-Insulated Switchgear

LKE
Medium
Voltage
Systems



FM 73638



LKE-GLBS (12/24kV SF₆ load break switch)

The **LKE-GLBS** is a 12/24 kV medium voltage load break switch designed for applications within indoor or outdoor medium voltage switchgear panels. It consists of a three position rotary switch mechanism mounted and sealed within an epoxy gas tank charged with SF₆ gas.

■ **The LKE-GLBS has the following features:**

- High load breaking capacity (transfer current or maximum breaking capacity of 2600A).
- Large creepage distances and superior insulation properties.
- Arc proof and tested for internal arcing.
- Maintenance free or low maintenance requirements
- Compact dimensions.
- Rugged design ensures long mechanical and electrical life.
- Low gas pressure system requiring less than 1 kg of SF₆ per switch.

The **LKE-GLBS** is a SF₆ load break switch which relies on the chemical properties of SF₆ for insulation and arc quenching. SF₆ has proven its reliability and advantages in electrical power equipment for a long time. As an inert, electro-negative and non-flammable gas with many physical and chemical advantage, it has been used for many years in circuit breakers on high-voltage systems and medium-voltage systems such as load-break switches and circuit breakers.

■ **Ambient conditions**

- Ambient temperature: -40 °C to +70 °C.
- Relative humidity: daily average of less than 95% and monthly average of less than 90%.
- Height above sea level of less than 1000 m.
- Earthquake intensity less than 8 degree.
- Environment: no frequent violent vibration.

■ **LKE-GLBS compliance with:**

- IEC 129 (earthing switch)
- IEC 265 (load break switch)
- IEC 420 (load break switch + fuses)



LKE-GLBS type load break switch (front view)



LKE-GLBS type load break switch (rear view)

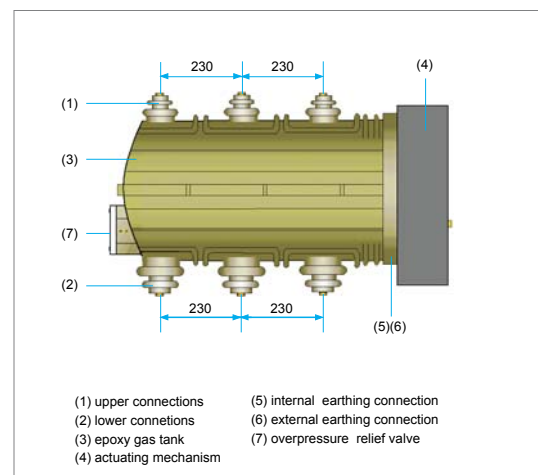

View of LKE-GLBS

LCA-G Air-Insulated Switchgear

The **LCA-G** switchboard is a modular system consisting of extensible panels.

They are ideal for applications where space limitations are severe.

Their compact dimensions make them ideal for applications within prefabricated mobile or underground substations. The modular system makes "**LCA-G**" the ideal solution in retro-fit or system expansion projects.

The reduced dimensions and weight of the cubicles allows for ease of handling and prompt installation.

Its safe and reliable design allows for a wide range of applications:

- Prefabricated outdoor substations and RMUs
- Industrial switchboard systems for M.V. power distribution
- As isolating devices in primary stations.
- Protection of downstream devices.

■ Ambient conditions

- Ambient temperature: -40 °C to +70 °C.
- Relative humidity: daily average of less than 95% and monthly average of less than 90%.
- Height above sea level of less than 1000 m.
- Earthquake intensity less than 8 degree.
- Environment: no frequent violent vibration.

■ Special operating conditions

The degree of protection of the **LCA-G** switch panel can be upgraded to IP 56. The **LCA-G** may also incorporate a temperature regulating module for extreme weather conditions.

■ LKE'S LCA-G was type-tested in compliance with the following standards:

- IEC 298



LCA-G Top section

LCA-G ring main unit (RMU)

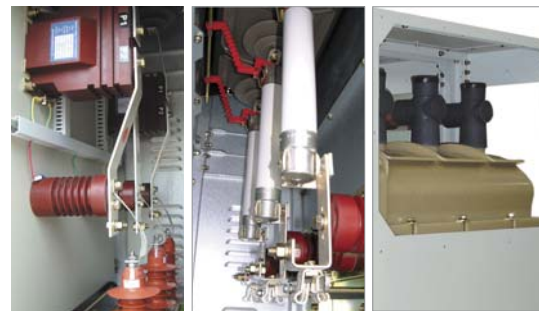

Internal view of service compartment for line units

Internal view of service compartment for transformer protection units

Version with fully insulated bus-bars available upon request

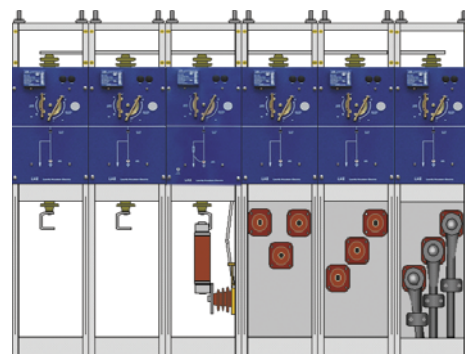

Extensible cubicles with various means of connection



Technical parameters

■ LKE-GLBS / AL, LKE-GLBS / BL and LCA-G1~G18 has the following parameters

Electrical Characteristics		Unit	IEC standards				
Rated Voltage		kV	7.2	12	15	17.5	24
Withstand voltage to earth and between poles		kV	20	28	36	38	50
Withstand voltage across isolating distance		kV	28	32	45	45	60
Impulse withstand voltage to earth and between poles		kV	60	75	95	95	125
Impulse withstand voltage across isolating distance		kV	70	85	110	110	145
Rated frequency		Hz	50/60				
Rated current		A	630				
Rated short -time current (Ik)	tk=1s systems	kA(max.)	25				
	tk=3s systems (choice)	kA	20				
Making capacity		kA(max.)	50				
Electrical endurance		times	500				
Mechanical endurance		times	5000				
Temperature	panel including : auxilliary instruments and relays	°C	-40 to +70				
	panel excluding : auxilliary instruments and relays	°C	-5 to +55				
Rated SF ₆ gas pressure (20 °C)		kPa	≥ 10				

■ LKE-GLBS / BF and LCA-G19~G24 has the following parameters

Electrical Characteristics		Unit	IEC standards				
Rated Voltage		kV	7.2	12	15	17.5	24
Withstand voltage to earth and between poles		kV	20	28	36	38	50
Withstand voltage across isolating distance		kV	28	32	45	45	60
Impulse withstand voltage to earth and between poles		kV	60	75	95	95	125
Impulse withstand voltage across isolating distance		kV	70	85	110	110	145
Rated frequency		Hz	50/60				
Rated current		A	630				
Rated short -time current (Ik)	tk=1s systems	kA(max.)	25				
	tk=3s systems (choice)	kA	20				
Making capacity		kA(max.)	50				
Max. breaking capacity (transfer current)		A	2600				
Rated short-circuit breaking current (fuses)		kA	31.5				
Electrical endurance		times	500				
Mechanical endurance		times	5000				
Temperature	panel including : auxilliary instruments and relays	°C	-40 to +70				
	panel excluding : auxilliary instruments and relays	°C	-5 to +55				
Rated SF ₆ gas pressure (20 °C)		kPa	≥ 10				



Layout of standard panels

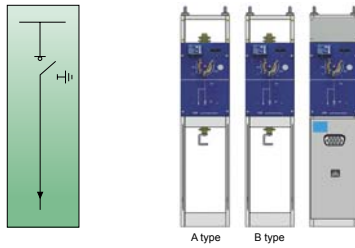

Line switch section LCA-G1	
Rated voltage	H X W X D (mm)
12kV	1500/1700X375X900*(1060)**
24kV	2000X500X1000

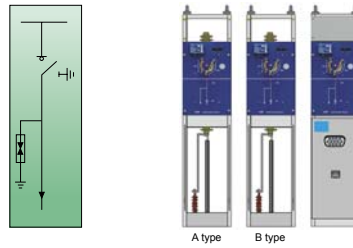

Line switch section LCA-G2	
Rated voltage	H X W X D (mm)
12kV	1500/1700X375X900*(1060)**
24kV	2000X500X1000

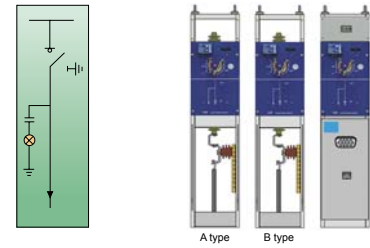

Line switch section LCA-G3	
Rated voltage	H X W X D (mm)
12kV	1500/1700X375X900*(1060)**
24kV	2000X500X1000

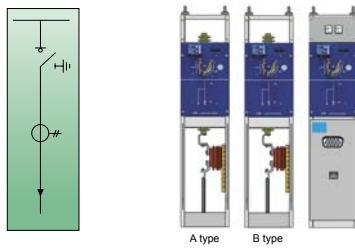

Line switch section LCA-G4	
Rated voltage	H X W X D (mm)
12kV	1500/1700X375X900*(1060)**
24kV	2000X500X1000

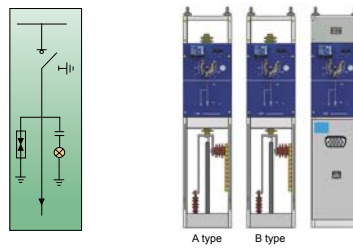

Line switch section LCA-G5	
Rated voltage	H X W X D (mm)
12kV	1500/1700X375X900*(1060)**
24kV	2000X500X1000

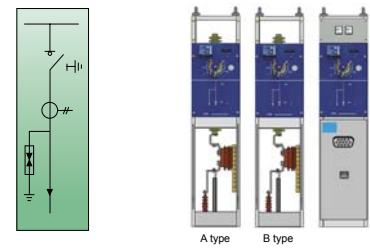

Line switch section LCA-G6	
Rated voltage	H X W X D (mm)
12kV	1700X375X900*(1060)**
24kV	2000X500X1000

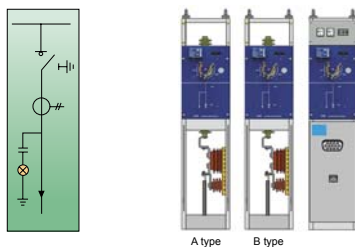

Line switch section LCA-G7	
Rated voltage	H X W X D (mm)
12kV	1500/1700X375X900*(1060)**
24kV	2000X500X1000

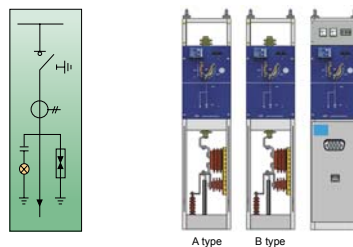

Line switch section LCA-G8	
Rated voltage	H X W X D (mm)
12kV	1700X500X900*(1060)**
24kV	2000X500X1000

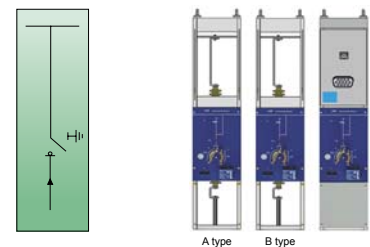

Line switch section LCA-G9	
Rated voltage	H X W X D (mm)
12kV	1500/1700X375X900*(1060)**
24kV	2000X500X1000

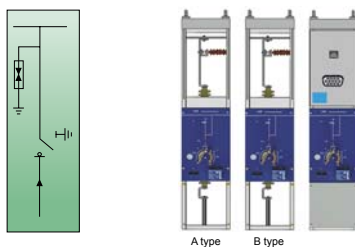

Line switch section LCA-G10	
Rated voltage	H X W X D (mm)
12kV	1500/1700X375X900*(1060)**
24kV	2000X500X1000

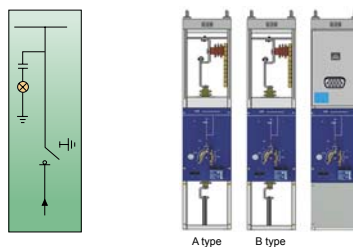

Line switch section LCA-G11	
Rated voltage	H X W X D (mm)
12kV	1500/1700X375X900*(1060)**
24kV	2000X500X1000

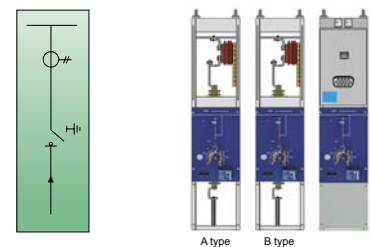

Line switch section LCA-G12	
Rated voltage	H X W X D (mm)
12kV	1500/1700X375X900*(1060)**
24kV	2000X500X1000

Layout of standard panels

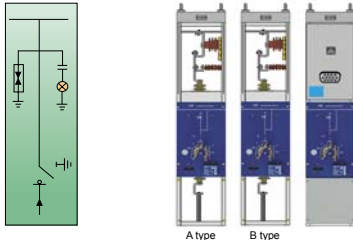

Line switch section LCA-G13	
Rated voltage	H X W X D (mm)
12kV	1500/1700X375X900*(1060)**
24kV	2000X500X1000

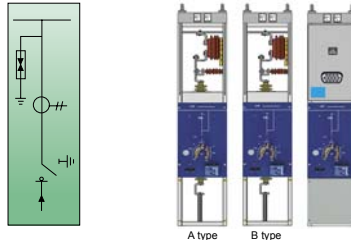

Line switch section LCA-G14	
Rated voltage	H X W X D (mm)
12kV	1700X375X900*(1060)**
24kV	2000X500X1000

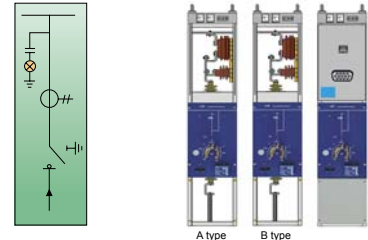

Line switch section LCA-G15	
Rated voltage	H X W X D (mm)
12kV	1500/1700X375X900*(1060)**
24kV	2000X500X1000

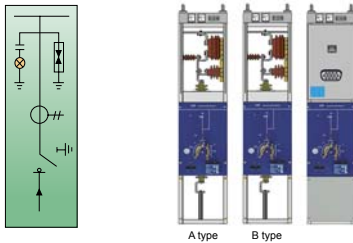

Line switch section LCA-G16	
Rated voltage	H X W X D (mm)
12kV	1700X500X900*(1060)**
24kV	2000X500X1000

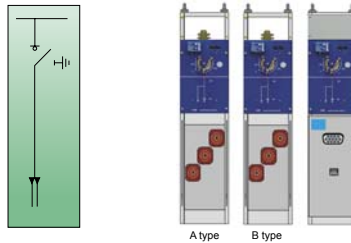

Line switch section LCA-G17	
Rated voltage	H X W X D (mm)
12kV	1700X375X900*(1060)**
24kV	2000X500X1000

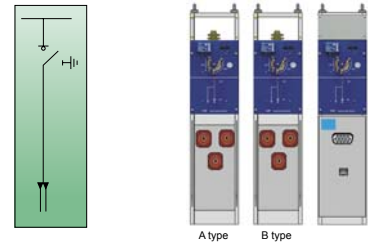

Line switch section LCA-G18	
Rated voltage	H X W X D (mm)
12kV	1500/1700X375X900*(1060)**
24kV	2000X500X1000

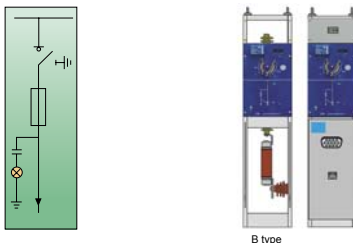

Transformer/downstream device protection section LCA-G19	
Rated voltage	H X W X D (mm)
12kV	1700X375X900*(1060)**
24kV	2000X500X1000

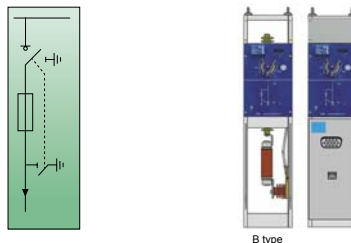

Transformer/downstream device protection section LCA-G20	
Rated voltage	H X W X D (mm)
12kV	1700X375X900*(1060)**
24kV	2000X500X1000

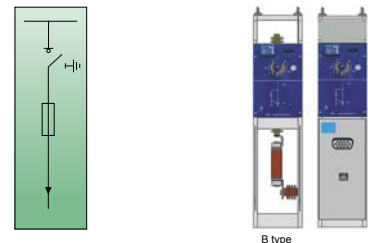

Transformer/downstream device protection section LCA-G21	
Rated voltage	H X W X D (mm)
12kV	1700X375X900*(1060)**
24kV	2000X500X1000

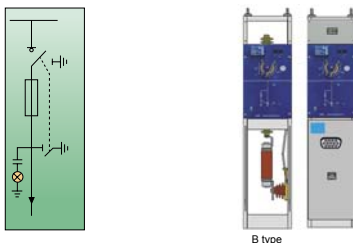

Transformer/downstream device protection section LCA-G22	
Rated voltage	H X W X D (mm)
12kV	1700X375X900*(1060)**
24kV	2000X500X1000

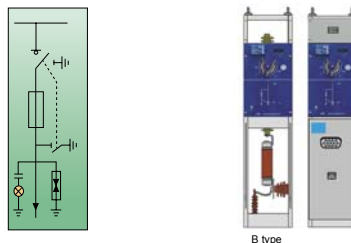

Transformer/downstream device protection section LCA-G23	
Rated voltage	H X W X D (mm)
12kV	1700X500X900*(1060)**
24kV	2000X500X1000

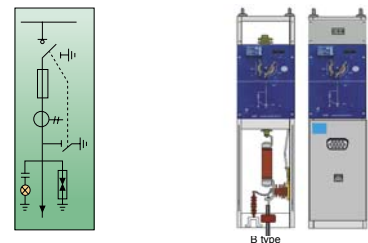

Transformer/downstream device protection section LCA-G24	
Rated voltage	H X W X D (mm)
12kV	1700X500X900*(1060)**
24kV	2000X500X1000